

IGBT

Preliminary data

- Low forward voltage drop
- High switching speed
- Low tail current
- Latch-up free
- Avalanche rated

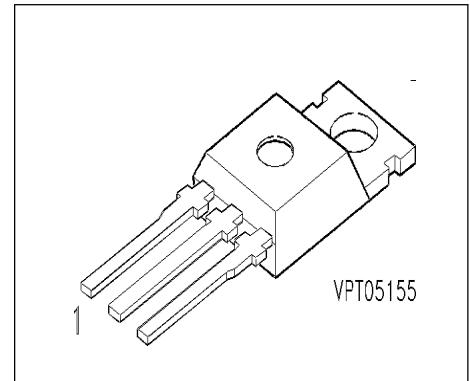

Pin 1	Pin 2	Pin 3
G	C	E

Type	V_{CE}	I_C	Package	Ordering Code
BUP 202	1000V	12A	TO-220 AB	Q67078-A4401-A2

Maximum Ratings

Parameter	Symbol	Values	Unit
Collector-emitter voltage	V_{CE}	1000	V
Collector-gate voltage	V_{CGR}	1200	
$R_{GE} = 20 \text{ k}\Omega$			
Gate-emitter voltage	V_{GE}	± 20	
DC collector current	I_C		A
$T_C = 25 \text{ }^\circ\text{C}$		12	
$T_C = 90 \text{ }^\circ\text{C}$		8	
Pulsed collector current, $t_p = 1 \text{ ms}$	I_{Cpuls}		
$T_C = 25 \text{ }^\circ\text{C}$		24	
$T_C = 90 \text{ }^\circ\text{C}$		16	
Avalanche energy, single pulse	E_{AS}		mJ
$I_C = 5 \text{ A}$, $V_{CC} = 24 \text{ V}$, $R_{GE} = 25 \text{ }\Omega$ $L = 3.3 \text{ mH}$, $T_j = 25 \text{ }^\circ\text{C}$		10	
Power dissipation	P_{tot}		W
$T_C = 25 \text{ }^\circ\text{C}$		100	
Chip or operating temperature	T_j	-55 ... + 150	$^\circ\text{C}$
Storage temperature	T_{stg}	-55 ... + 150	

Maximum Ratings

Parameter	Symbol	Values	Unit
DIN humidity category, DIN 40 040	-	E	-
IEC climatic category, DIN IEC 68-1	-	55 / 150 / 56	

Thermal Resistance

IGBT thermal resistance, chip case	R_{thJC}	≤ 1	K/W
------------------------------------	------------	----------	-----

Electrical Characteristics, at $T_j = 25\text{ }^\circ\text{C}$, unless otherwise specified

Parameter	Symbol	Values			Unit
		min.	typ.	max.	

Static Characteristics

Gate threshold voltage $V_{GE} = V_{CE}, I_C = 0.3\text{ mA}$	$V_{GE(th)}$	4.5	5.5	6.5	V
Collector-emitter saturation voltage $V_{GE} = 15\text{ V}, I_C = 5\text{ A}, T_j = 25\text{ }^\circ\text{C}$ $V_{GE} = 15\text{ V}, I_C = 5\text{ A}, T_j = 125\text{ }^\circ\text{C}$ $V_{GE} = 15\text{ V}, I_C = 5\text{ A}, T_j = 150\text{ }^\circ\text{C}$	$V_{CE(sat)}$	-	2.8 3.8 4	3.3 4.3 4.5	
Zero gate voltage collector current $V_{CE} = 1000\text{ V}, V_{GE} = 0\text{ V}, T_j = 25\text{ }^\circ\text{C}$ $V_{CE} = 1000\text{ V}, V_{GE} = 0\text{ V}, T_j = 125\text{ }^\circ\text{C}$	I_{CES}	-	1 -	100 300	μA
Gate-emitter leakage current $V_{GE} = 20\text{ V}, V_{CE} = 0\text{ V}$	I_{GES}	-	0.1	100	nA

AC Characteristics

Transconductance $V_{CE} = 20\text{ V}, I_C = 1.5\text{ A}$	g_{fs}	1.7	2.5	-	S
Input capacitance $V_{CE} = 25\text{ V}, V_{GE} = 0\text{ V}, f = 1\text{ MHz}$	C_{iss}	-	650	870	pF
Output capacitance $V_{CE} = 25\text{ V}, V_{GE} = 0\text{ V}, f = 1\text{ MHz}$	C_{oss}	-	50	80	
Reverse transfer capacitance $V_{CE} = 25\text{ V}, V_{GE} = 0\text{ V}, f = 1\text{ MHz}$	C_{rss}	-	20	30	

Electrical Characteristics, at $T_j = 25\text{ °C}$, unless otherwise specified

Parameter	Symbol	Values			Unit
		min.	typ.	max.	

Switching Characteristics, Inductive Load at $T_j = 125\text{ °C}$

Turn-on delay time $V_{CC} = 600\text{ V}$, $V_{GE} = 15\text{ V}$, $I_C = 5\text{ A}$ $R_{Gon} = 68\ \Omega$	$t_{d(on)}$	-	30	50	ns
Rise time $V_{CC} = 600\text{ V}$, $V_{GE} = 15\text{ V}$, $I_C = 5\text{ A}$ $R_{Gon} = 68\ \Omega$	t_r	-	20	30	
Turn-off delay time $V_{CC} = 600\text{ V}$, $V_{GE} = -15\text{ V}$, $I_C = 5\text{ A}$ $R_{Goff} = 68\ \Omega$	$t_{d(off)}$	-	180	270	
Fall time $V_{CC} = 600\text{ V}$, $V_{GE} = -15\text{ V}$, $I_C = 5\text{ A}$ $R_{Goff} = 68\ \Omega$	t_f	-	15	25	
Total turn-off loss energy $V_{CC} = 600\text{ V}$, $V_{GE} = -15\text{ V}$, $I_C = 5\text{ A}$ $R_{Goff} = 68\ \Omega$	E_{off}	-	0.7	-	

Power dissipation

$$P_{\text{tot}} = f(T_C)$$

parameter: $T_j \leq 150^\circ\text{C}$

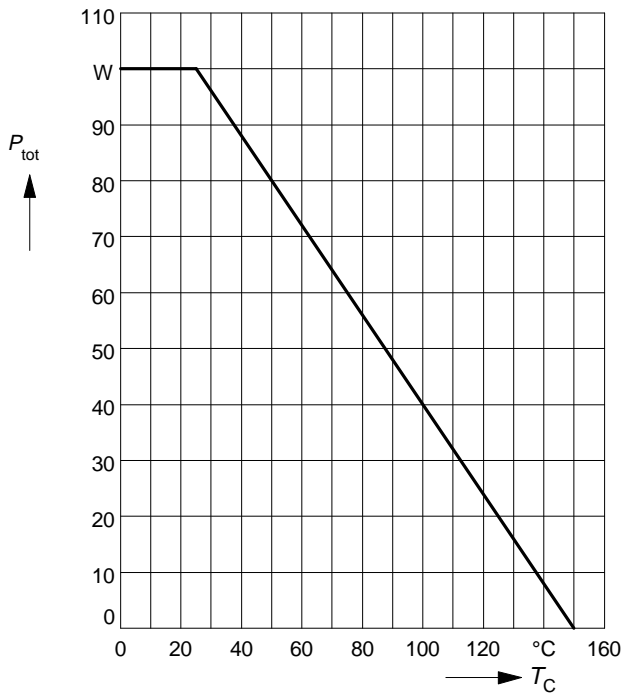

Collector current

$$I_C = f(T_C)$$

parameter: $V_{\text{GE}} \geq 15\text{ V}$, $T_j \leq 150^\circ\text{C}$

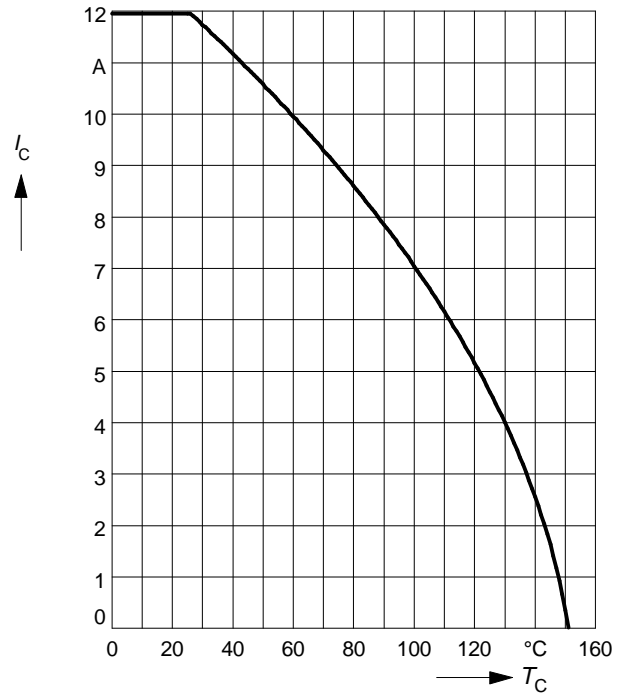

Safe operating area

$$I_C = f(V_{\text{CE}})$$

parameter: $D = 0$, $T_C = 25^\circ\text{C}$, $T_j \leq 150^\circ\text{C}$

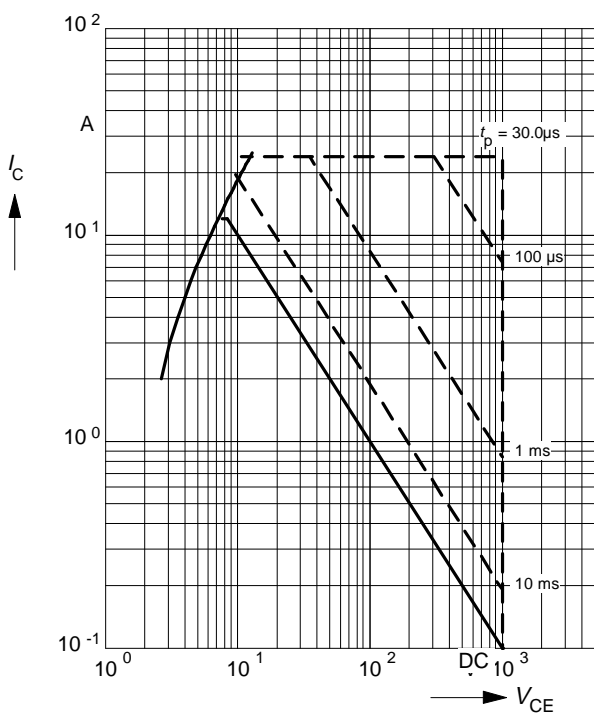

Transient thermal impedance IGBT

$$Z_{\text{thJC}} = f(t_p)$$

parameter: $D = t_p / T$

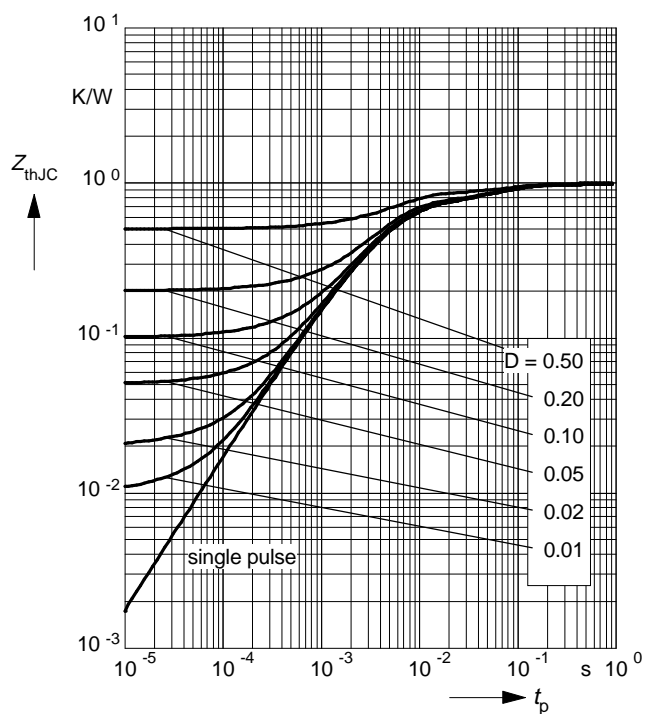

Typ. output characteristics

$$I_C = f(V_{CE})$$

parameter: $t_p = 80 \mu s$, $T_j = 125 \text{ }^\circ C$

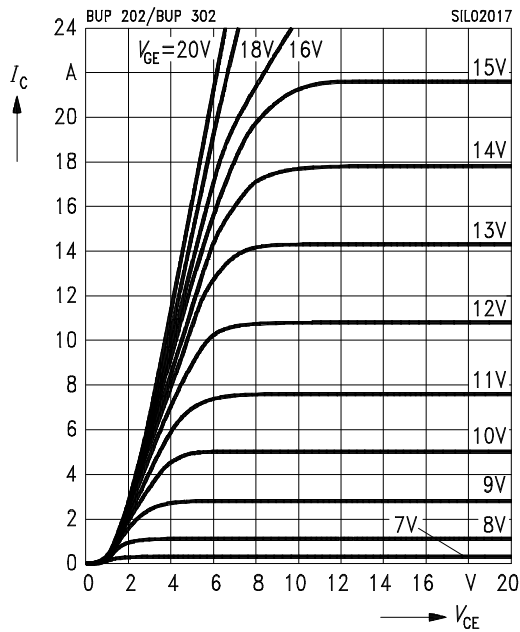

Typ. transfer characteristics

$$I_C = f(V_{GE})$$

parameter: $t_p = 80 \mu s$, $V_{CE} = 20 \text{ V}$, $T_j = 25 \text{ }^\circ C$

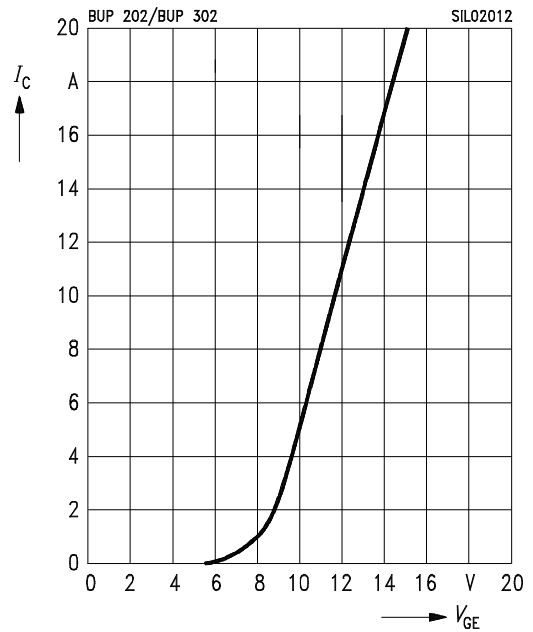

Typ. saturation characteristics

$$V_{CE(sat)} = f(V_{GE})$$

parameter: $T_j = 25 \text{ }^\circ C$

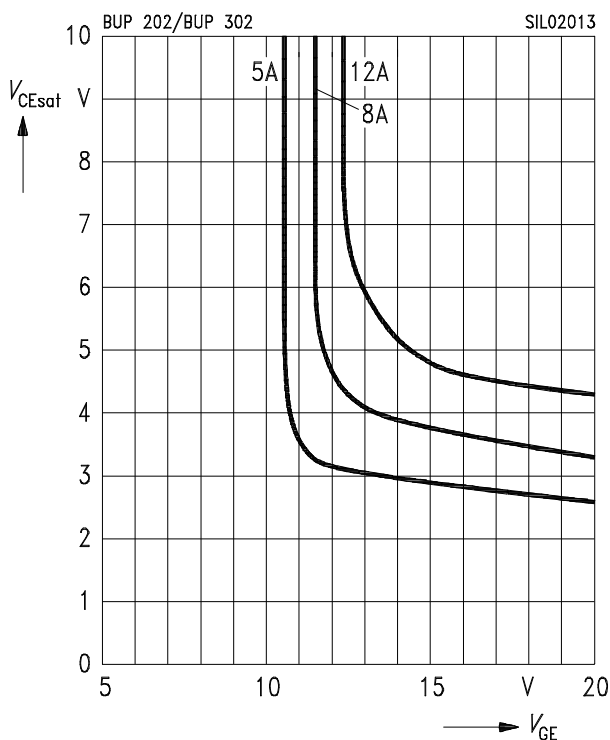

Typ. saturation characteristics

$$V_{CE(sat)} = f(V_{GE})$$

parameter: $T_j = 125 \text{ }^\circ C$

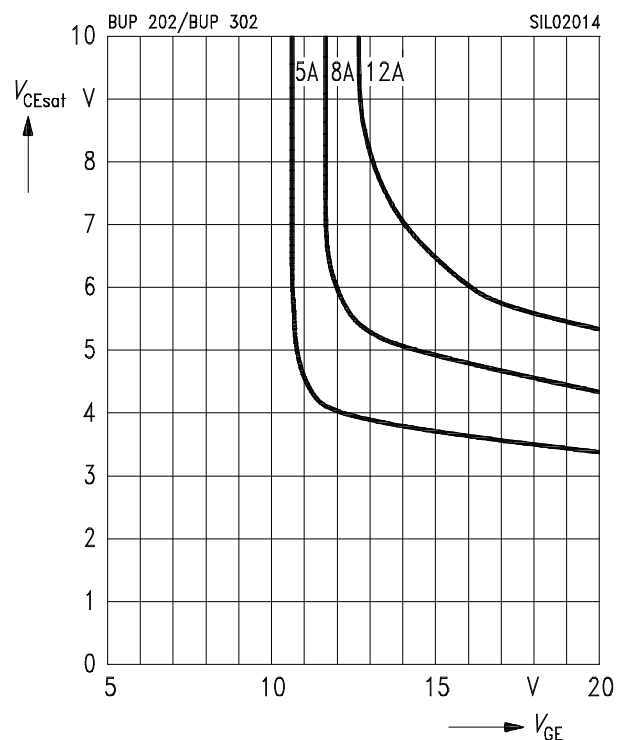

Typ. gate charge

$$V_{GE} = f(Q_{Gate})$$

parameter: $I_{C\ puls} = 6\ A$

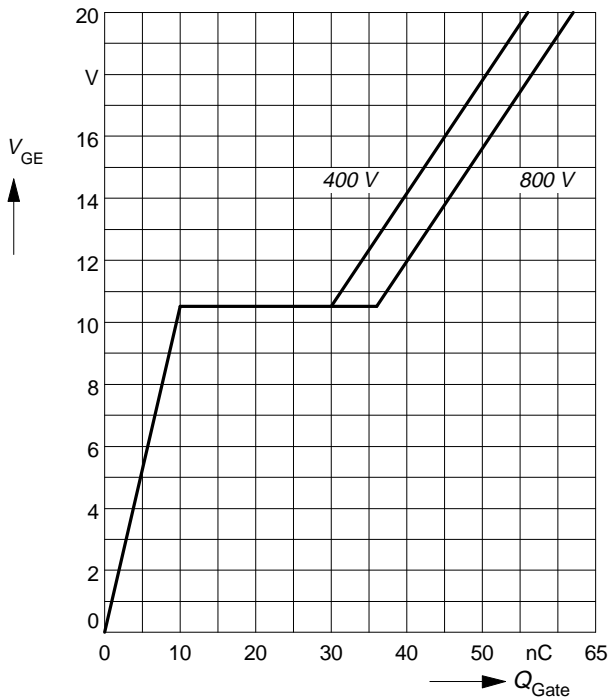

Typ. capacitances

$$C = f(V_{CE})$$

parameter: $V_{GE} = 0\ V, f = 1\ MHz$

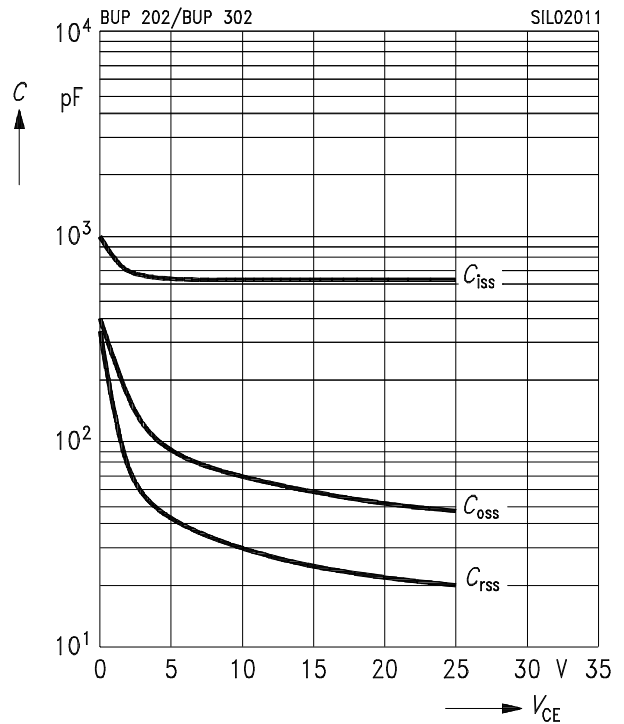

Typ. switching time

$t = f(R_G)$, inductive load, $T_j = 125\ ^\circ C$

parameter: $V_{CE} = 600\ V, V_{GE} = \pm 15\ V, I_C = 5\ A$

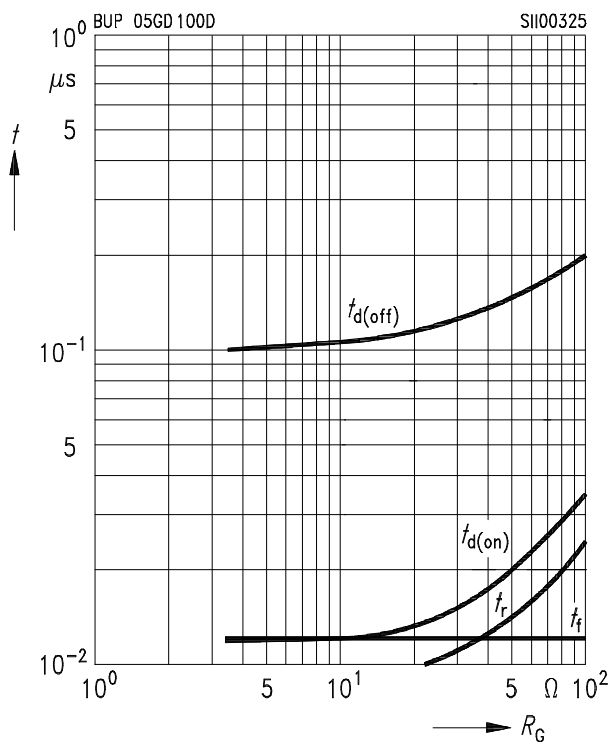

Package Outlines

Dimensions in mm

Weight: 8 g

